

Cutting Gordian's "End-User Focus" vs. "Privacy" Knot

KDE Academy 2024
Björn Balazs | bjoern@privact.org

A  privact.org project together with  funded by  Prototype
Fund

The KDE Manifesto

[...] End-User Focus to ensure our work is useful to all people.
[...]

The KDE Vision

[...] Privacy: In a world where our privacy is increasingly threatened, we wanted to emphasize its importance. Freedom without the right to privacy is no freedom at all. [...]



USER DEVICES

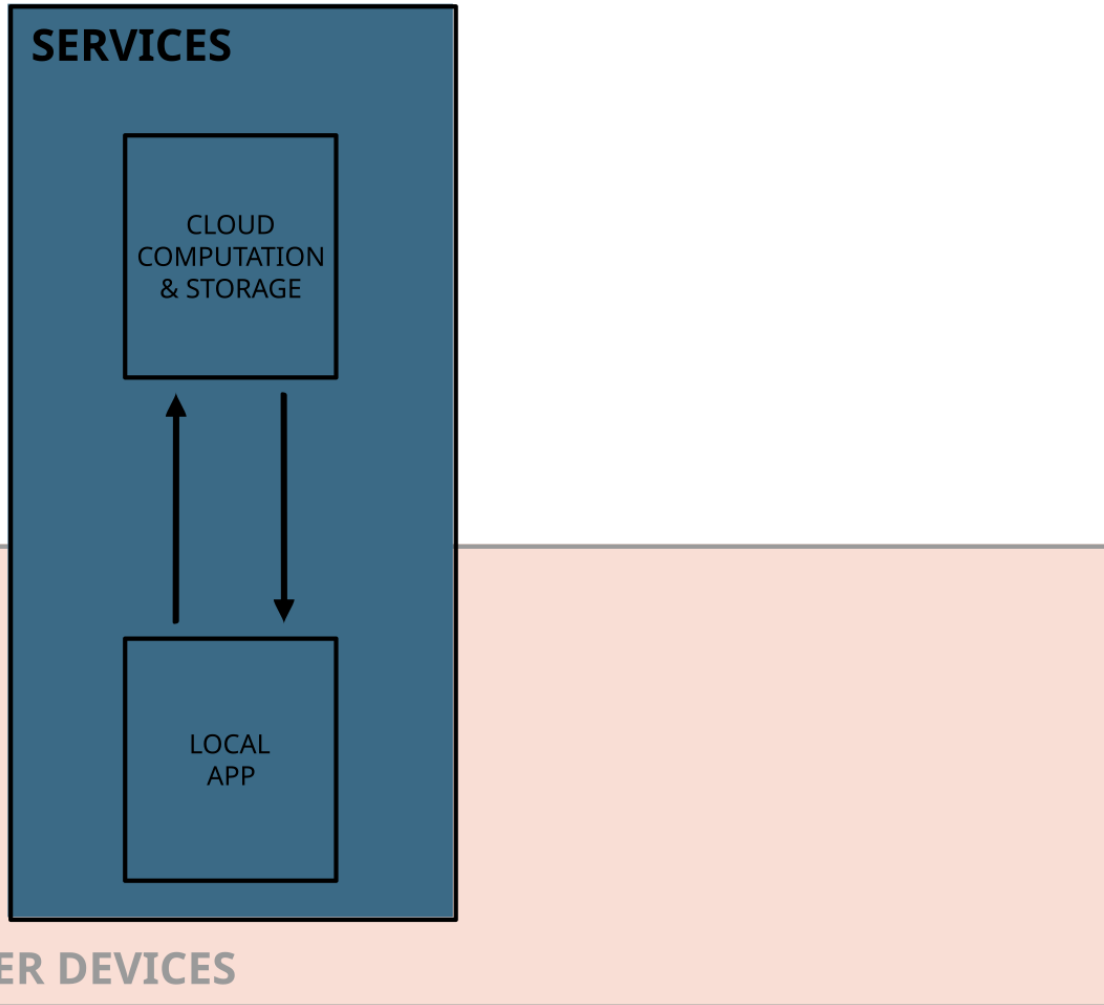

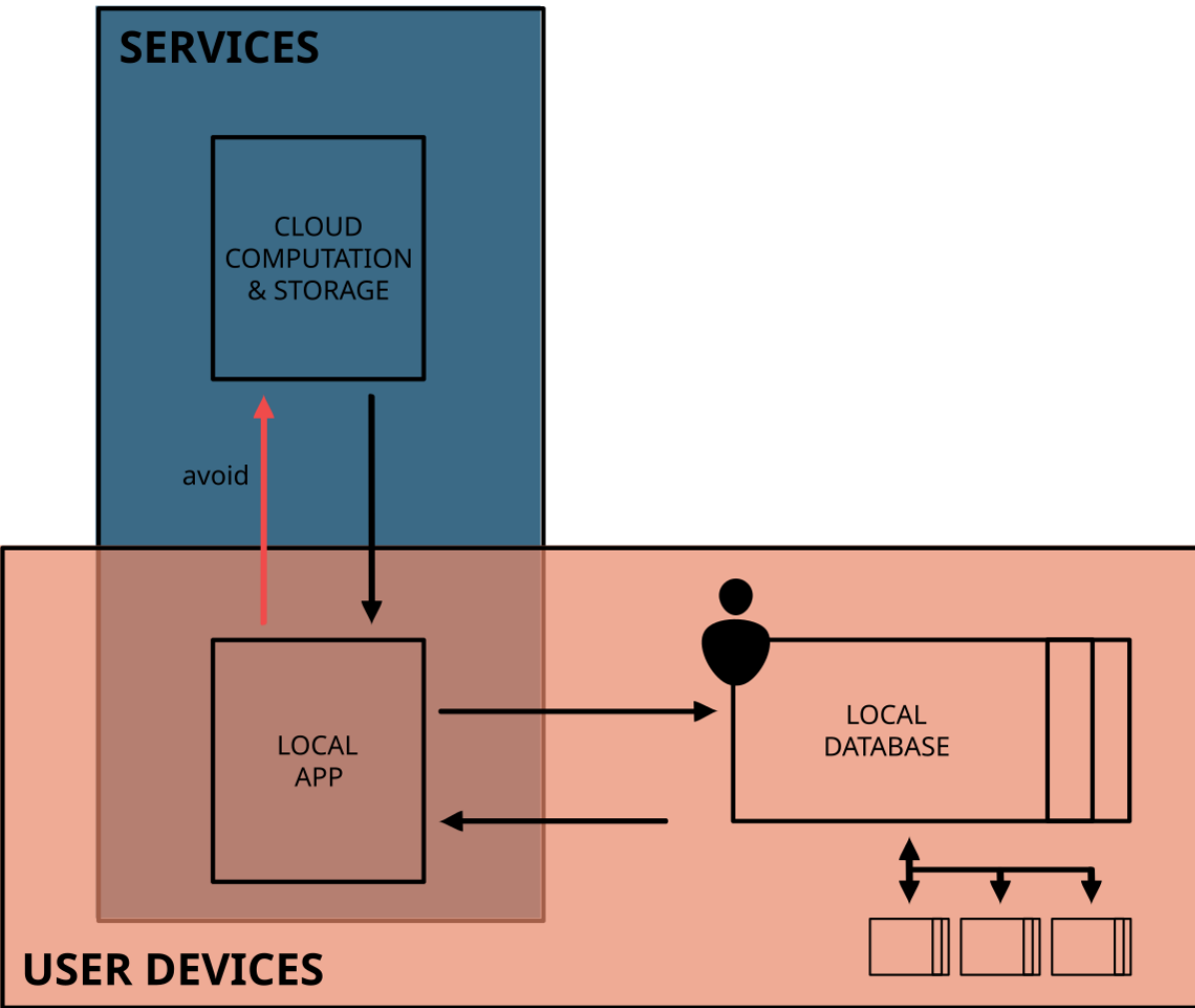

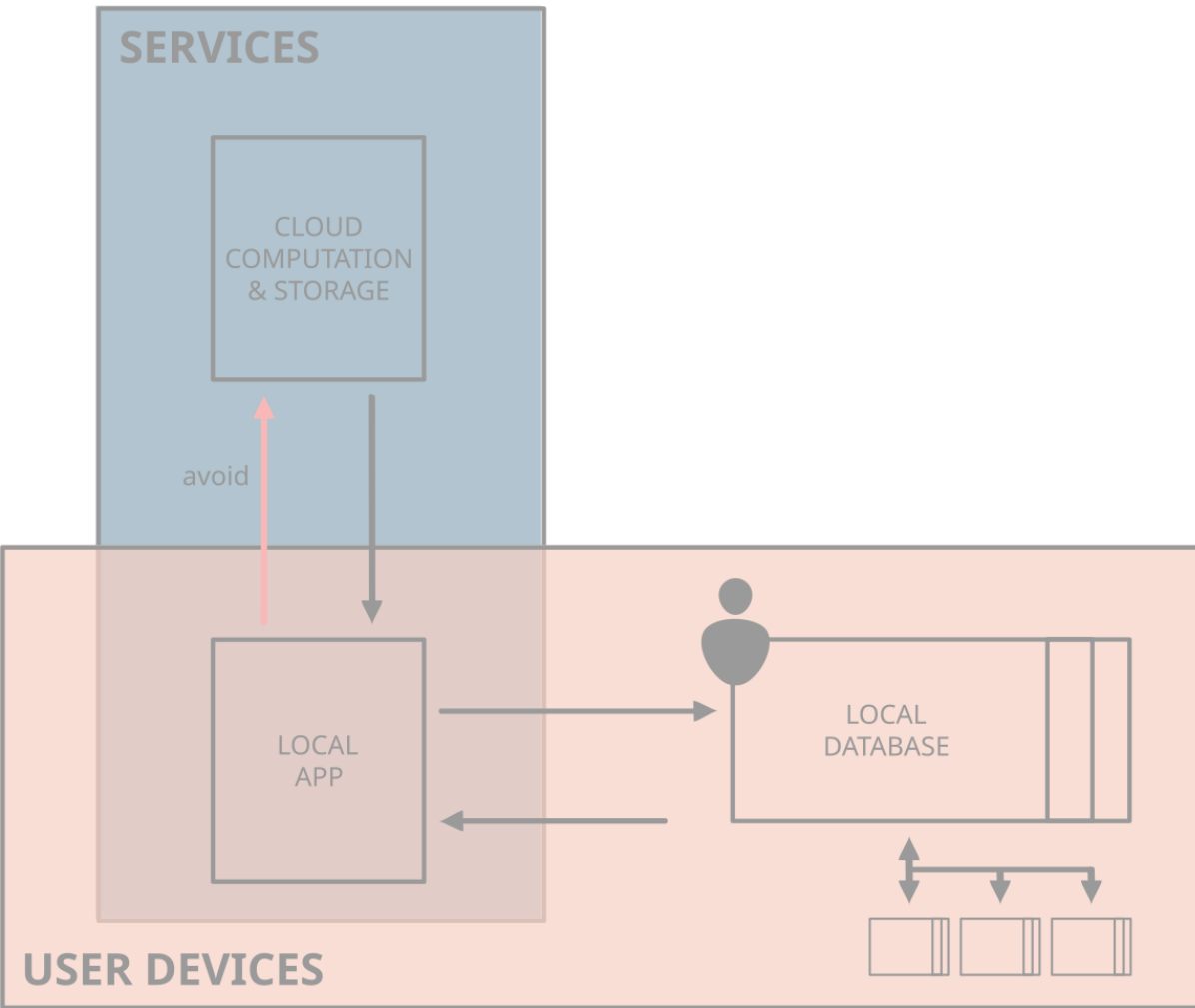

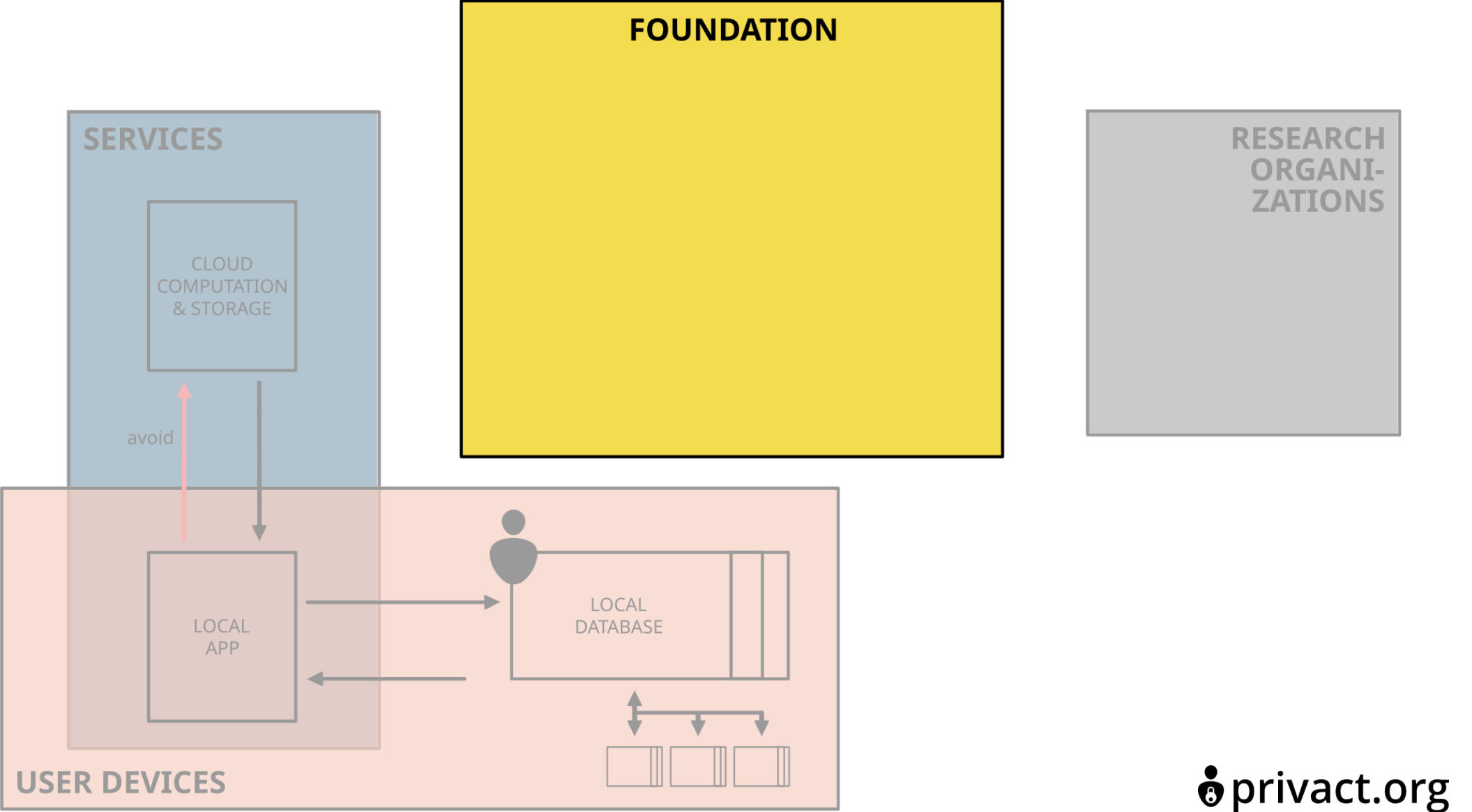

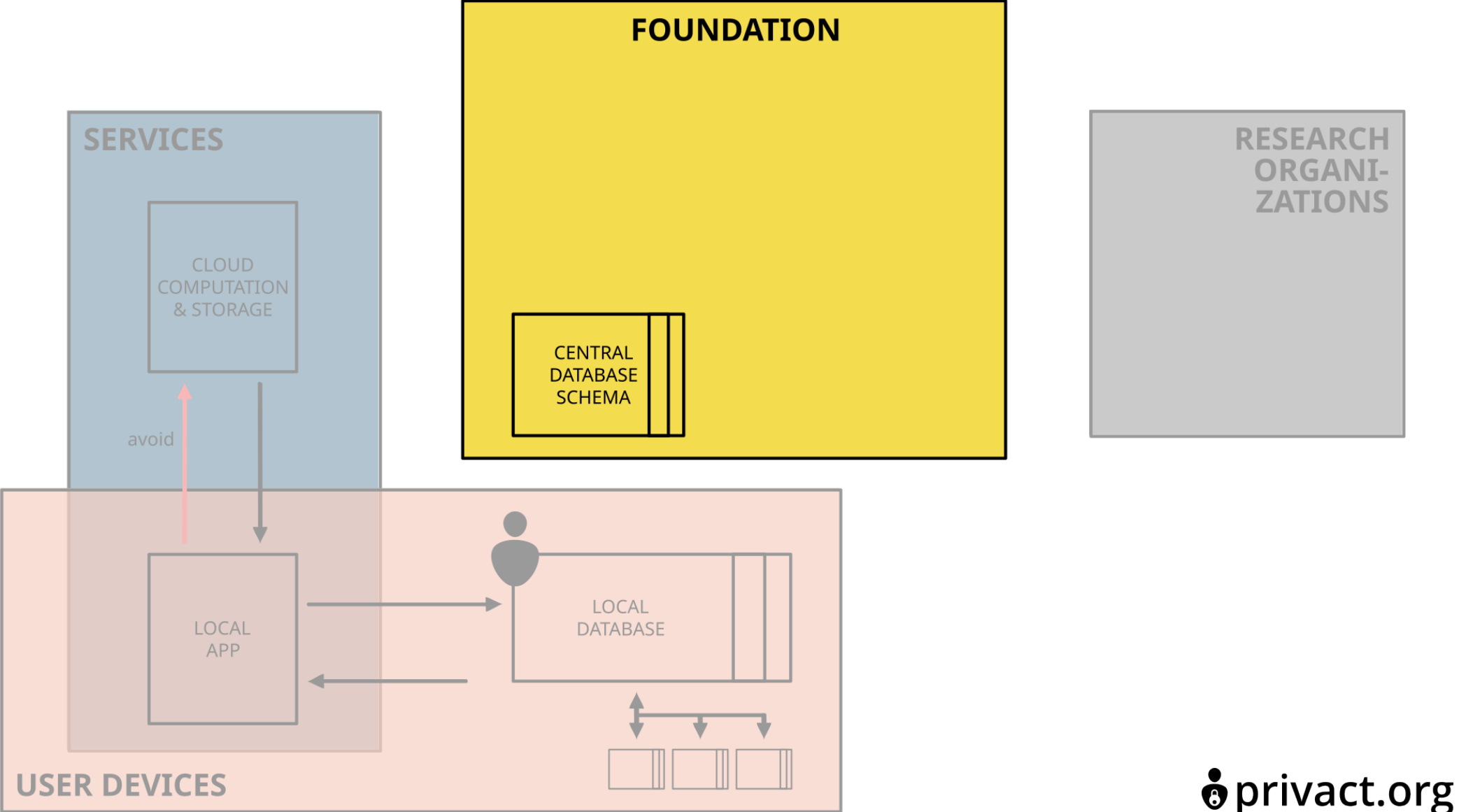

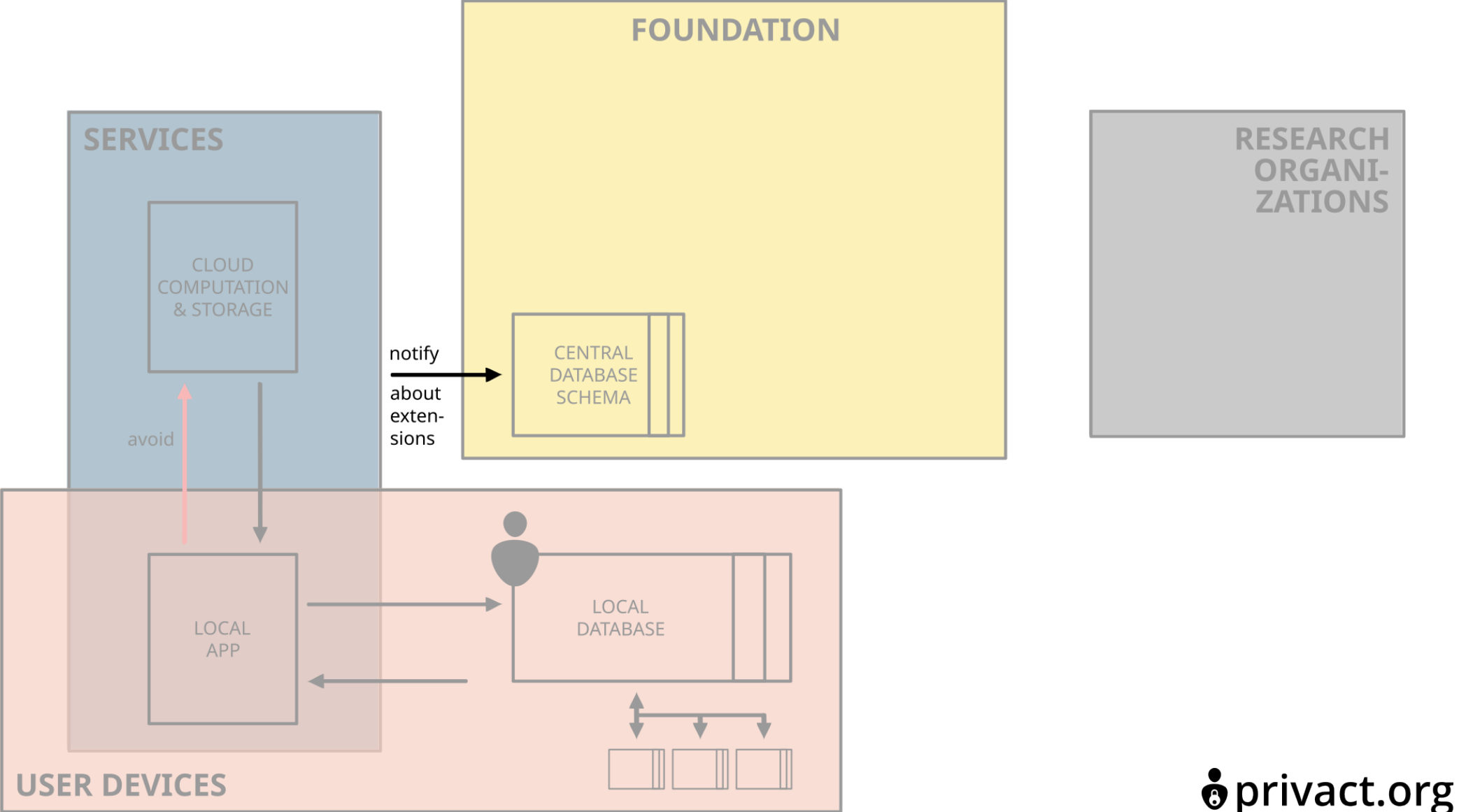

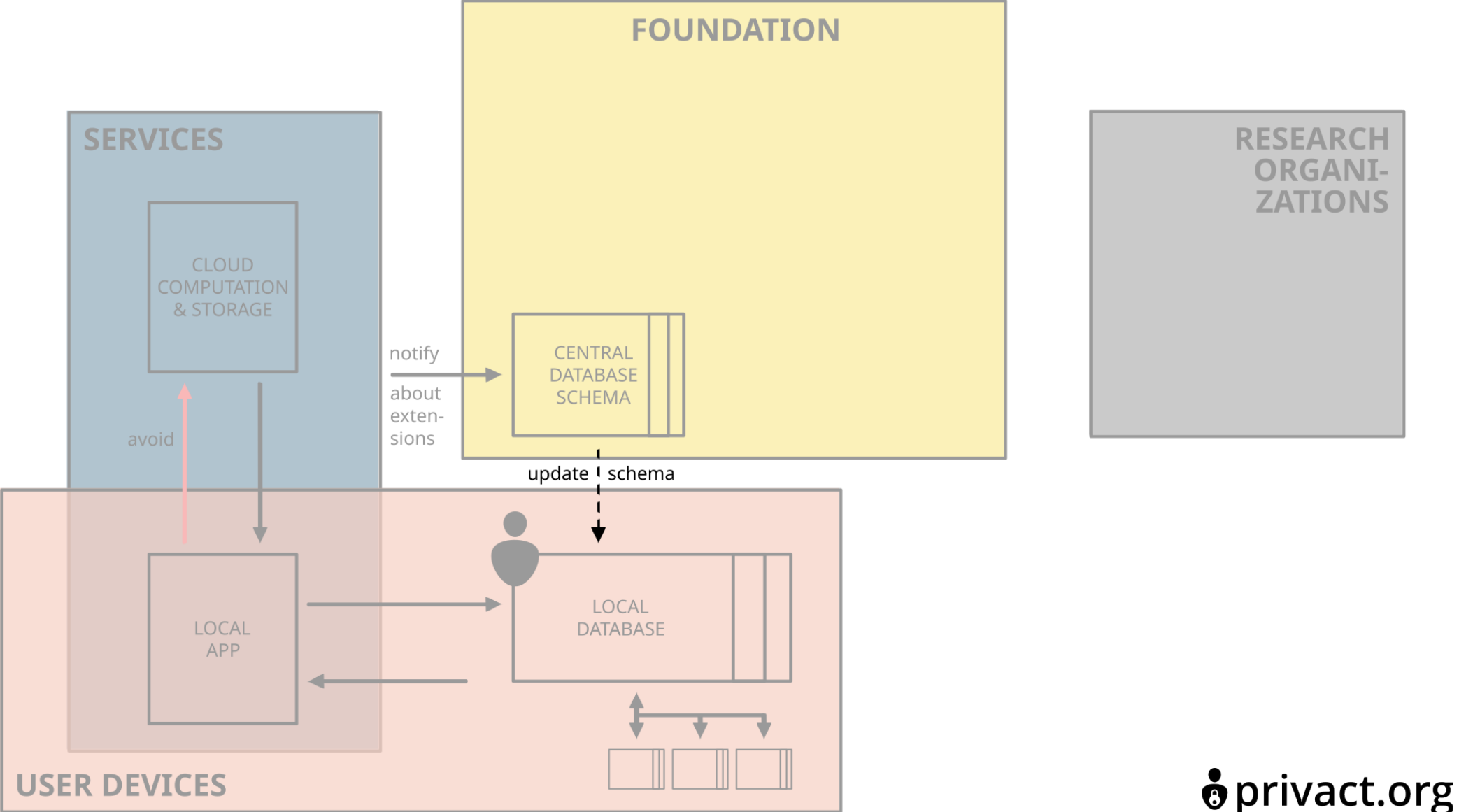

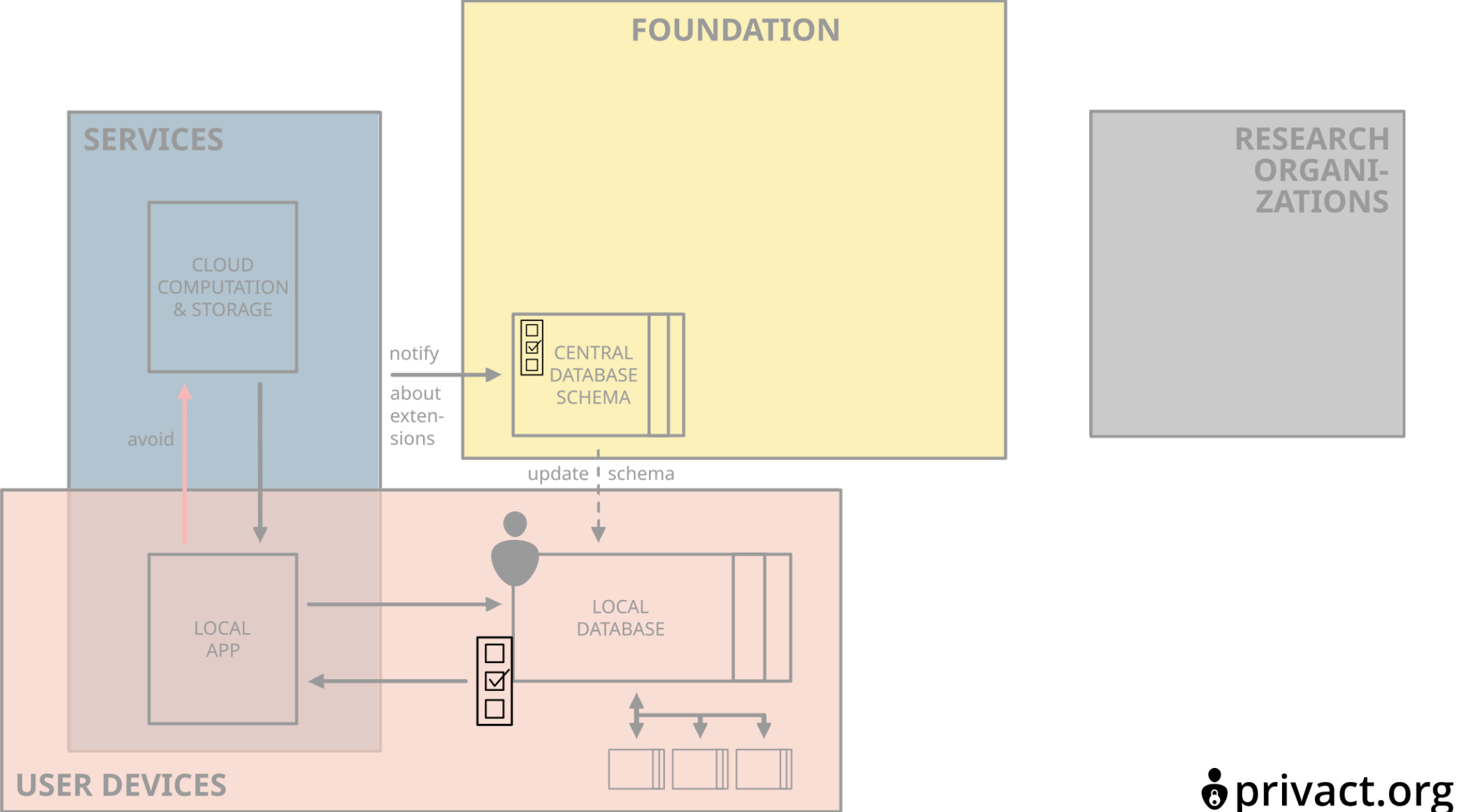

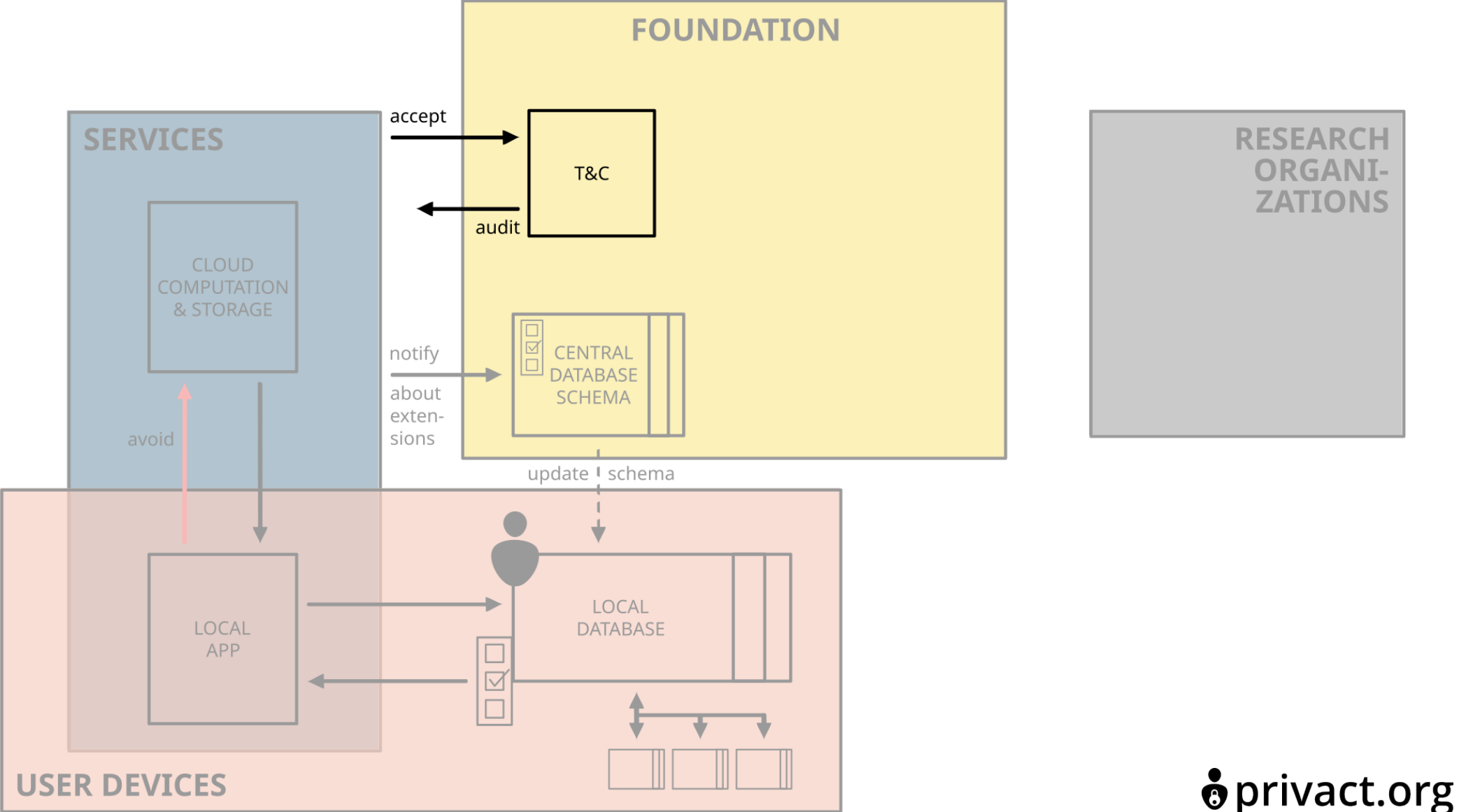

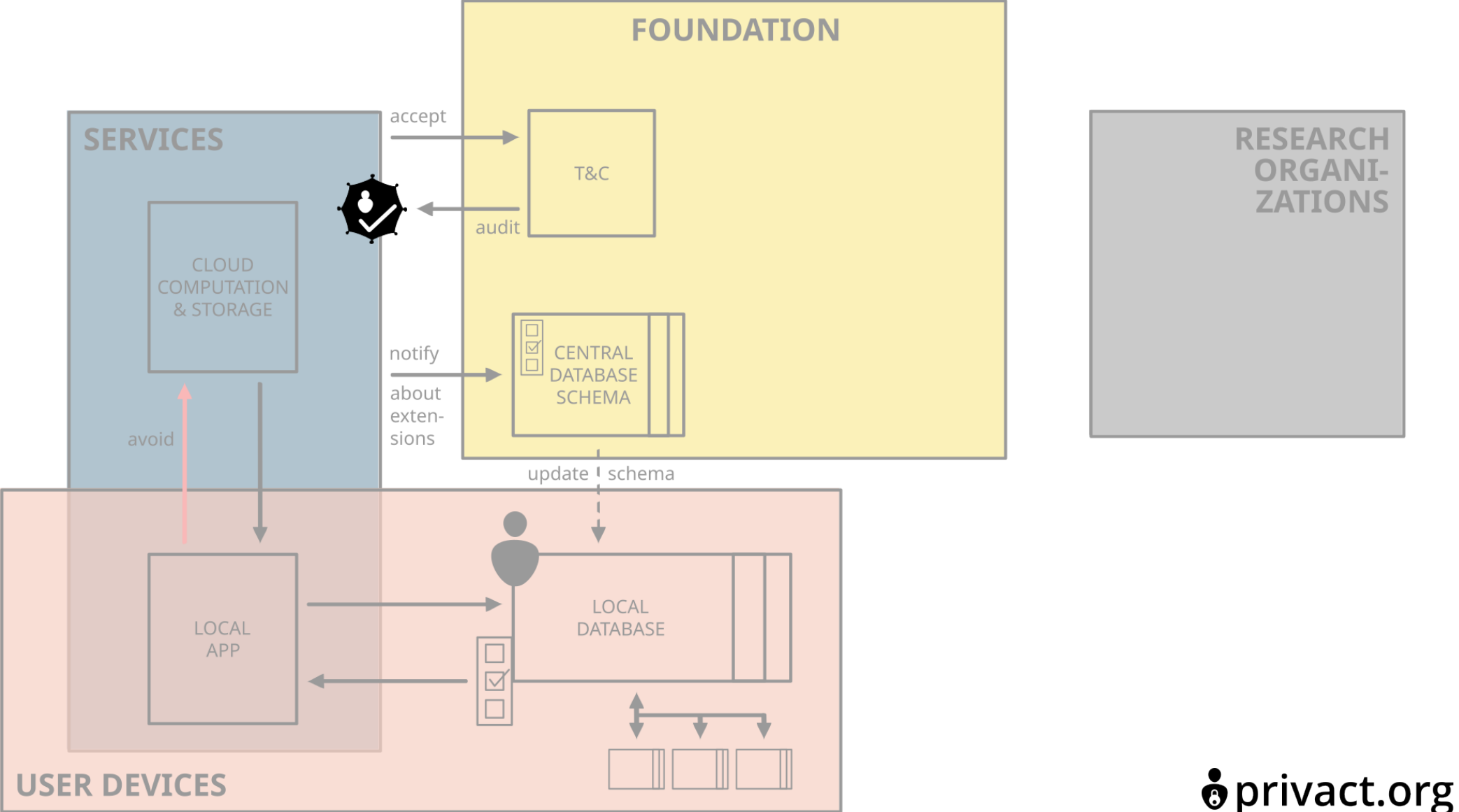

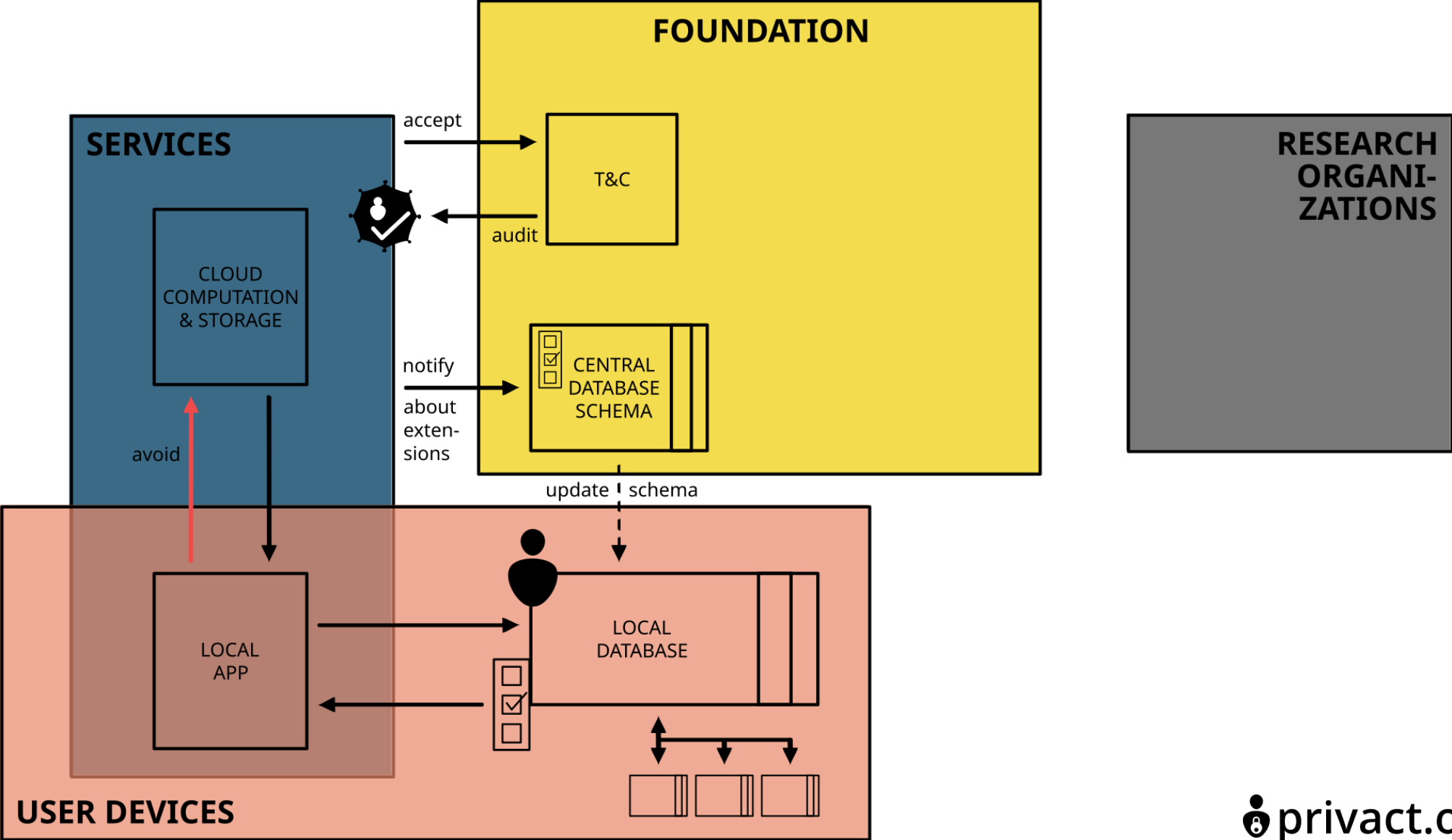

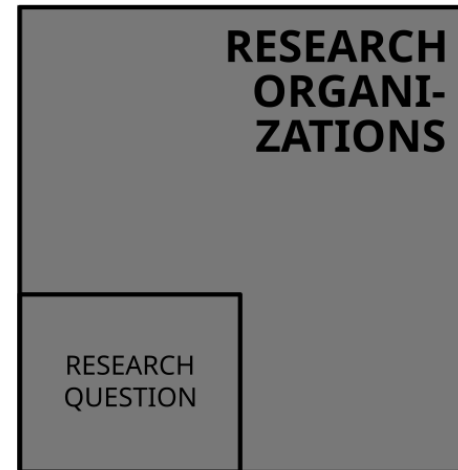
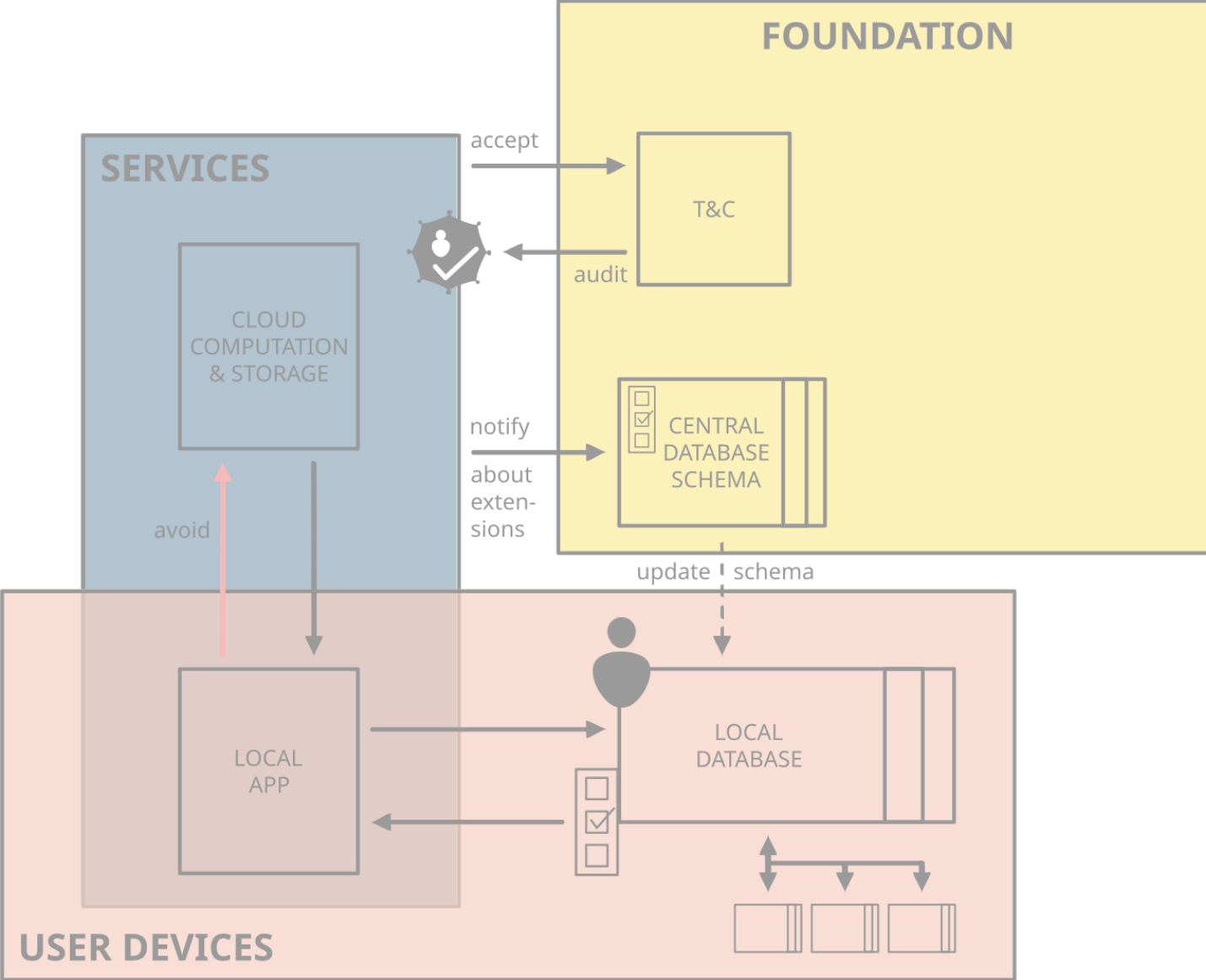

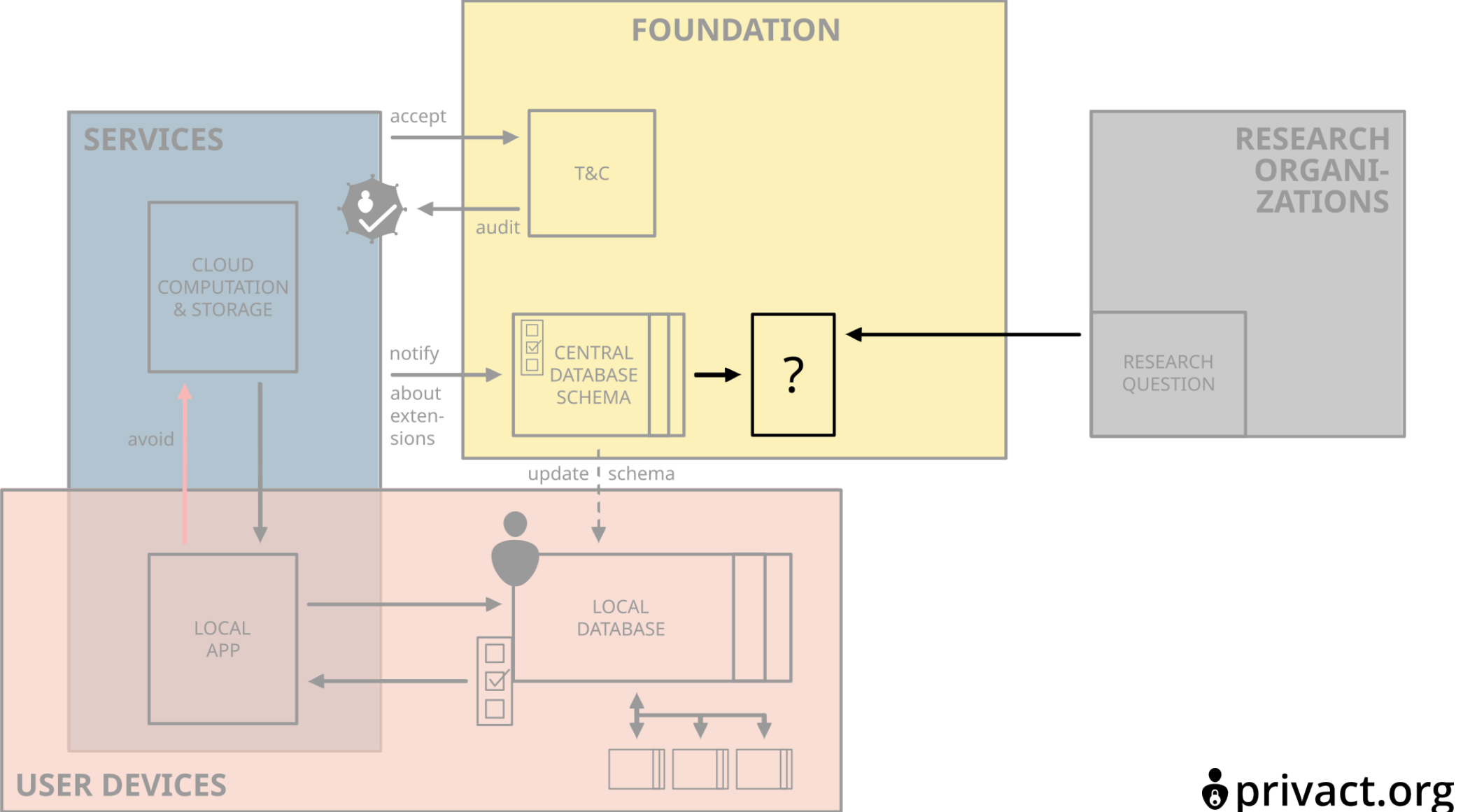

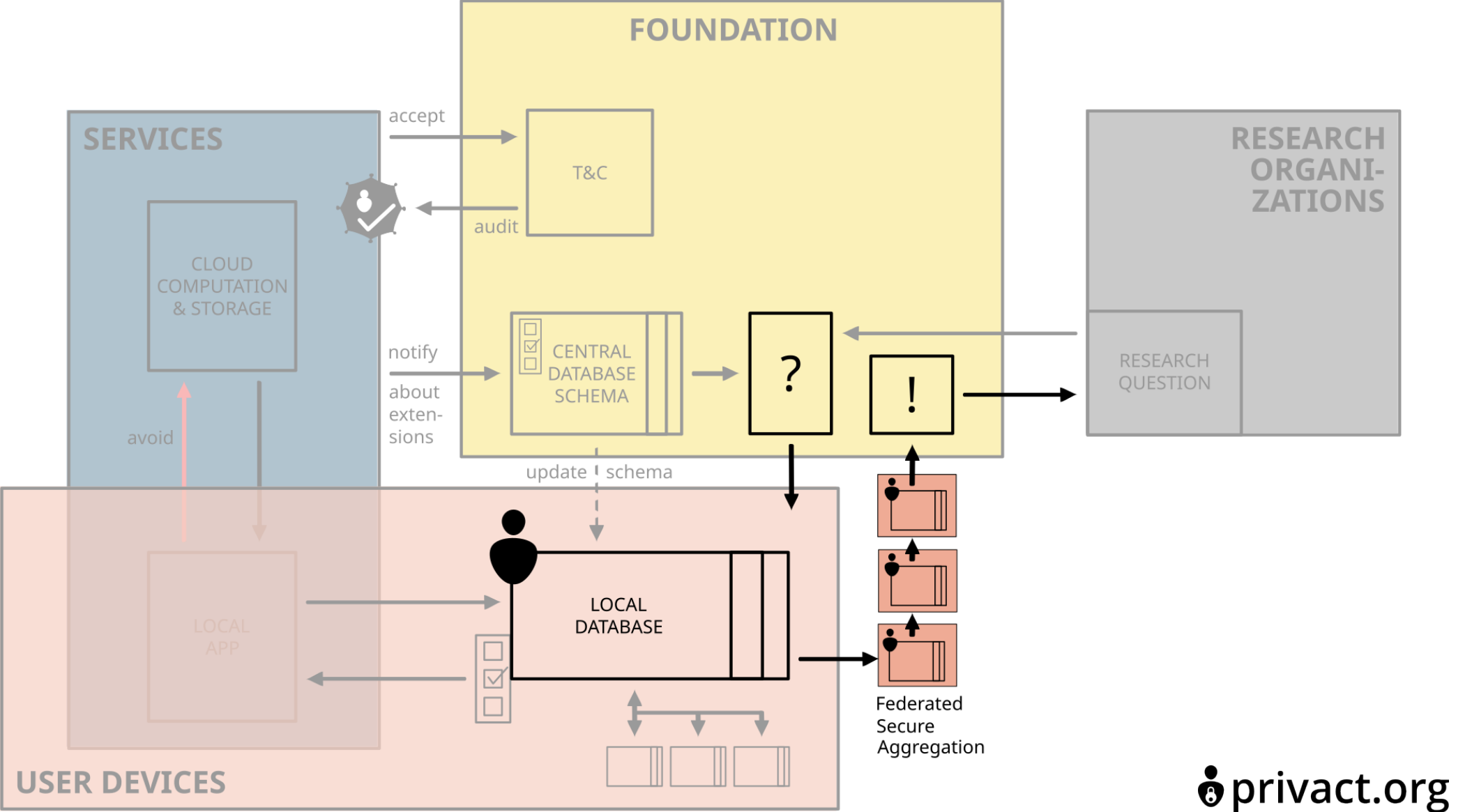

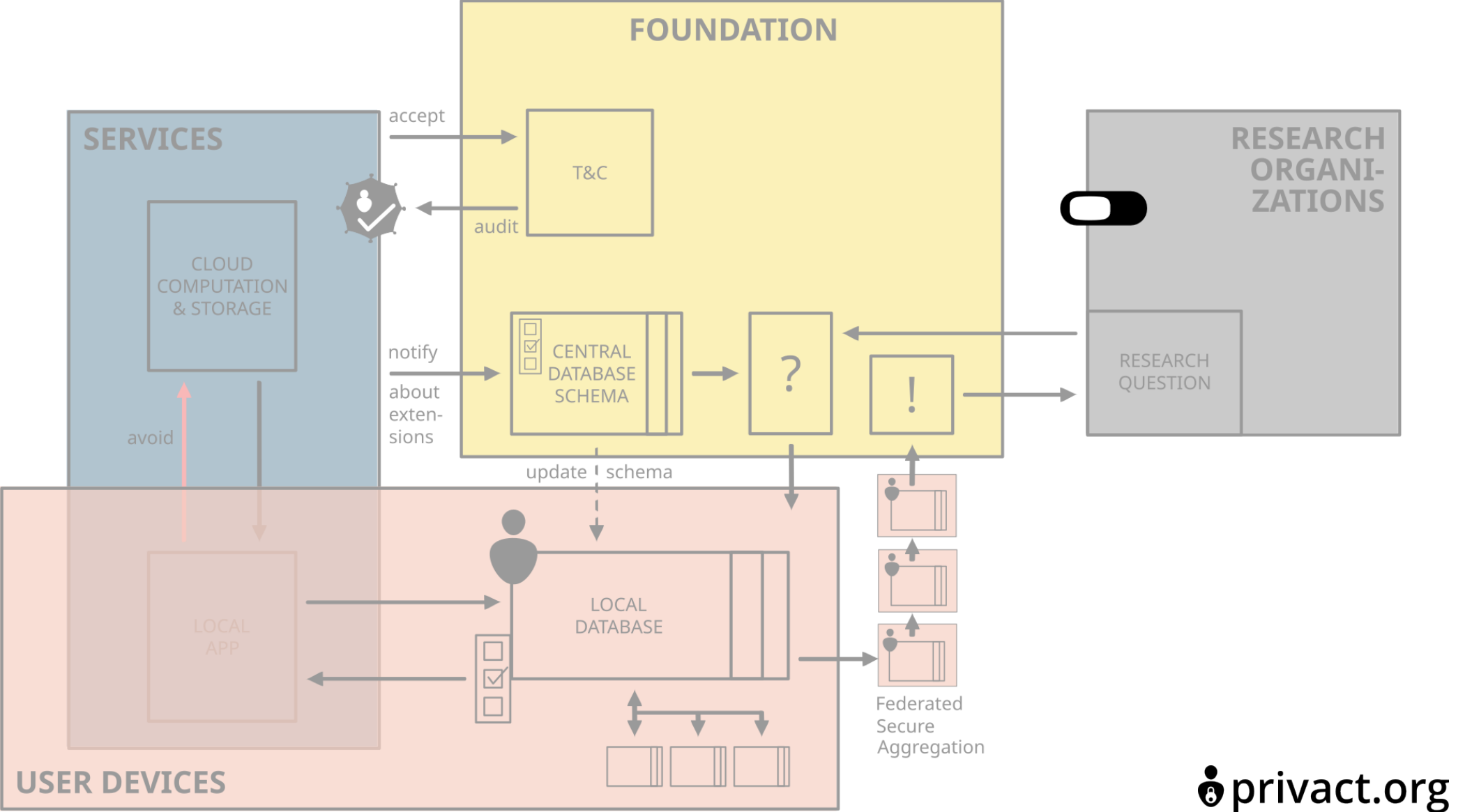

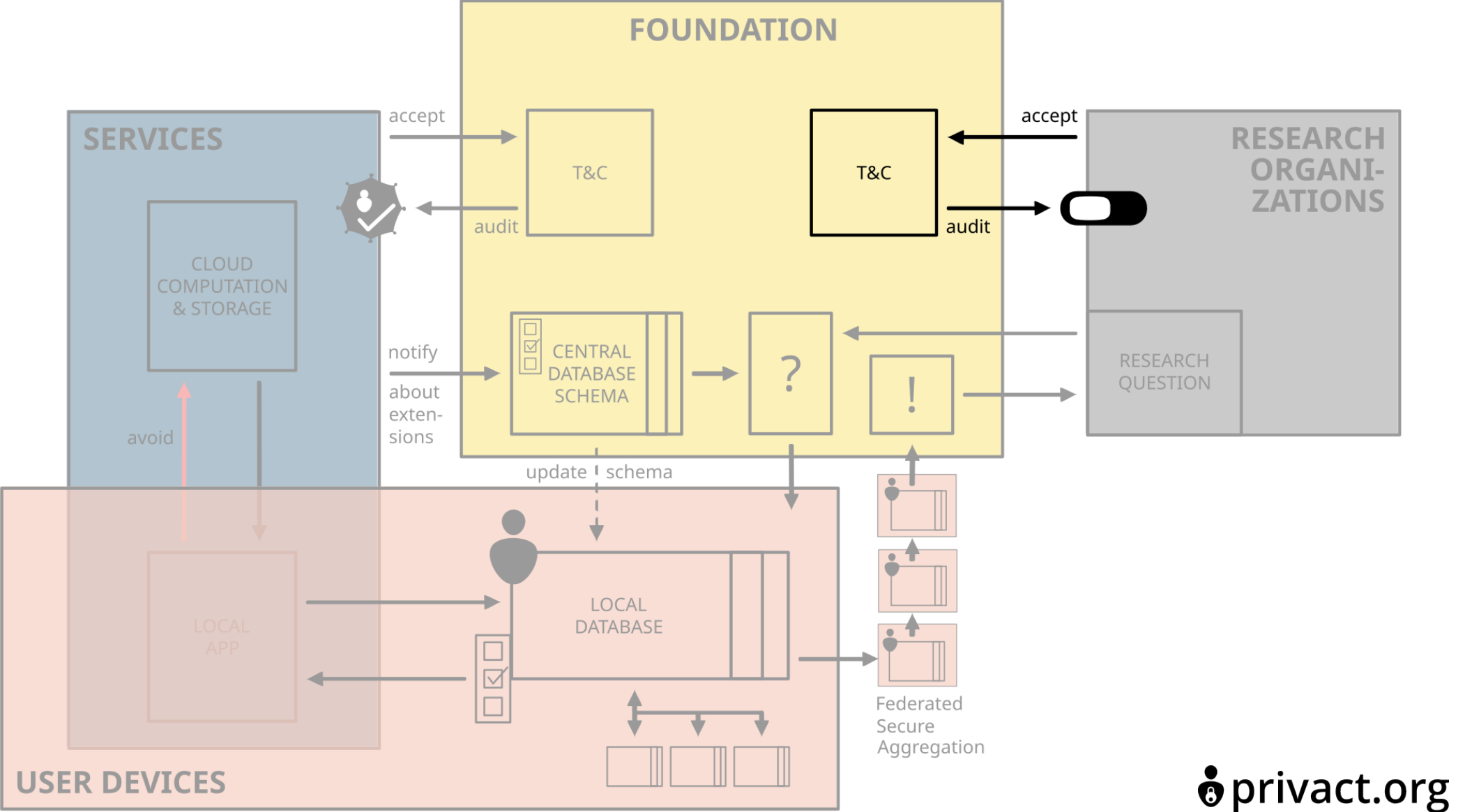

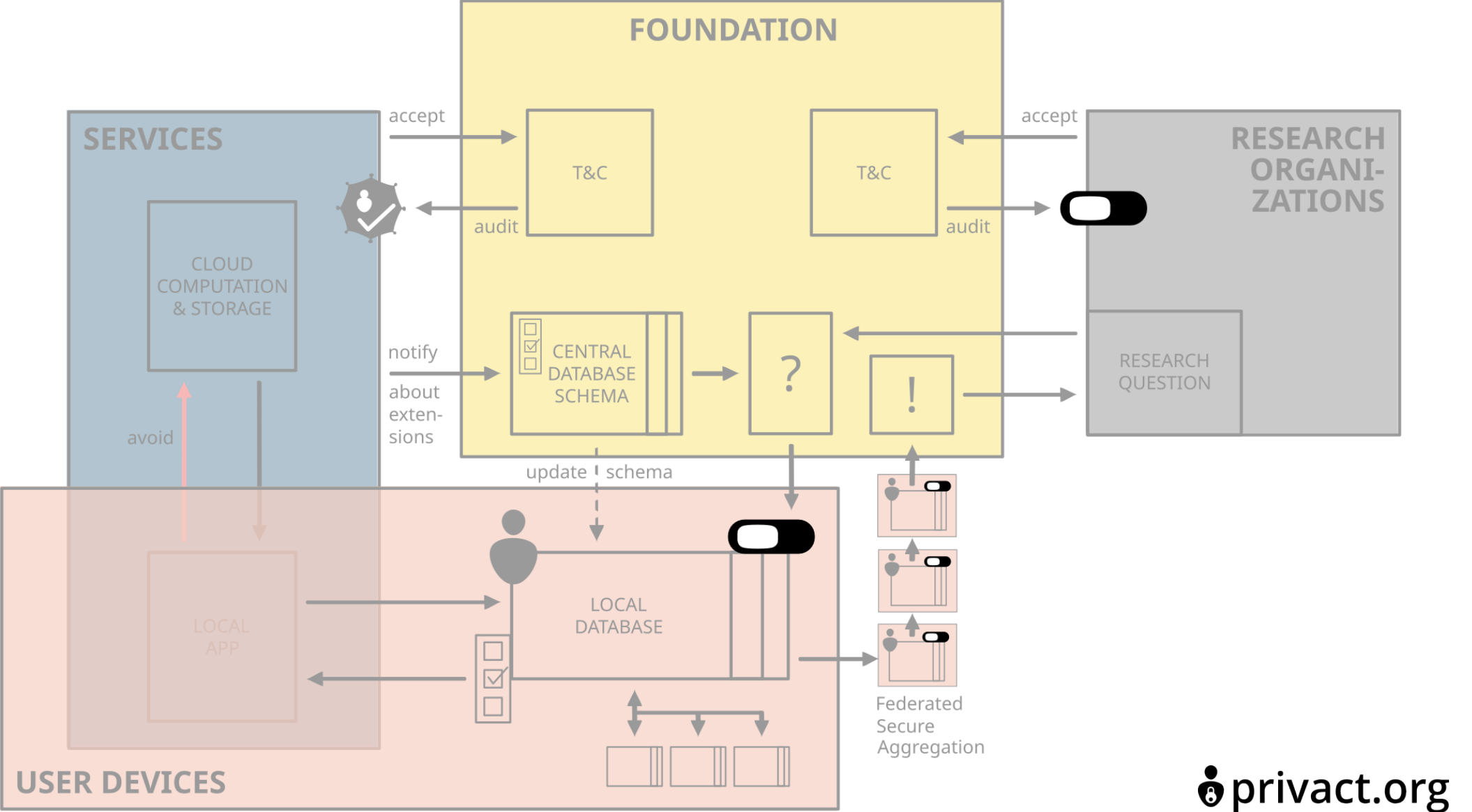

1

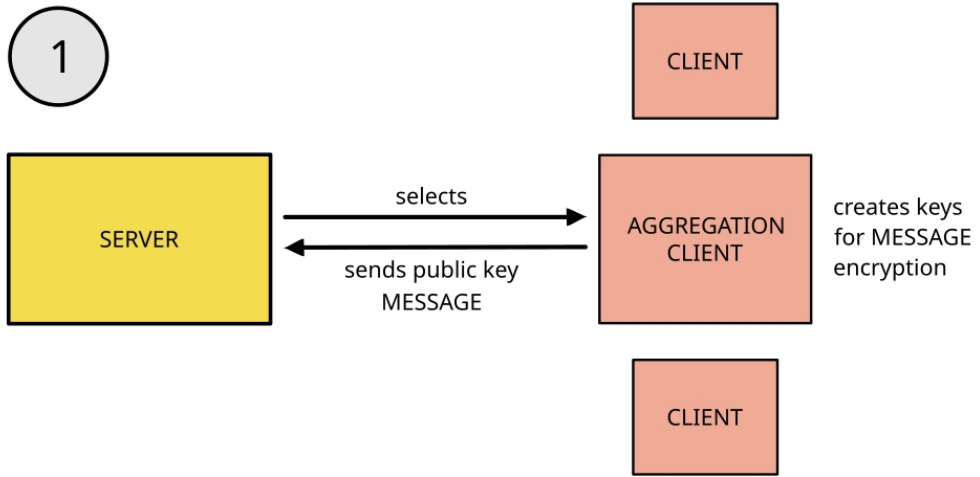

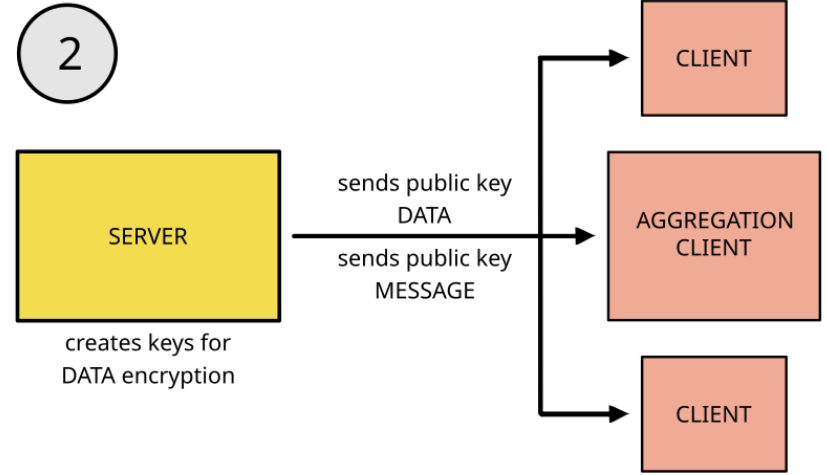
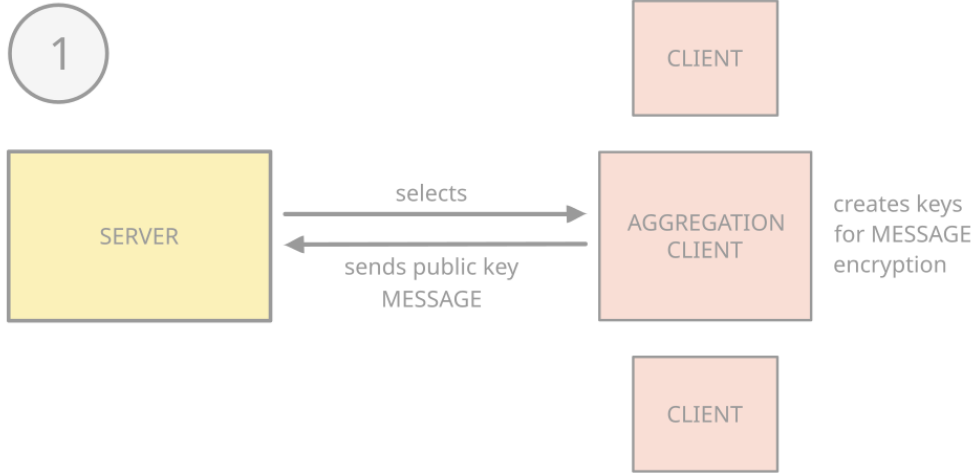

1

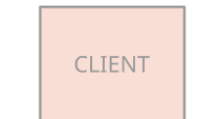
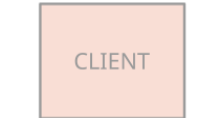
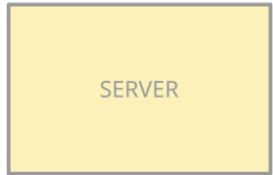

creates keys for MESSAGE encryption

2

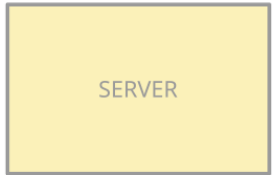

creates keys for DATA encryption

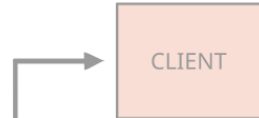

3

encrypt DATA using Paillier cryptosystem
encrypt MESSAGE using DH asymmetric cryptography

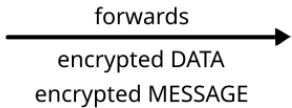
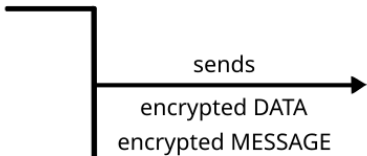

decrypts MESSAGE
aggregates encrypted DATA using Paillier cryptosystem

1

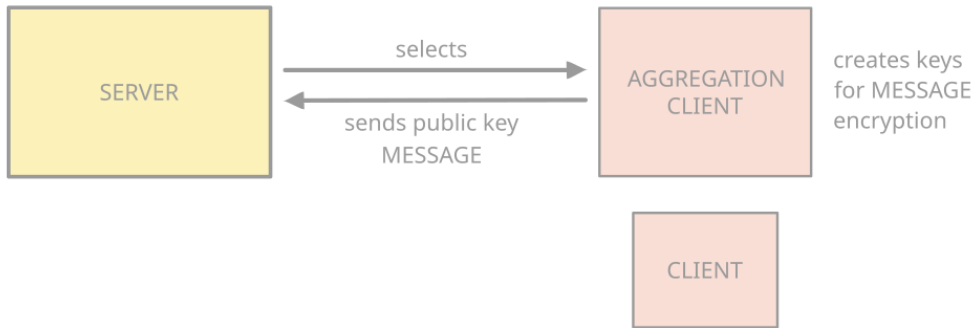

2

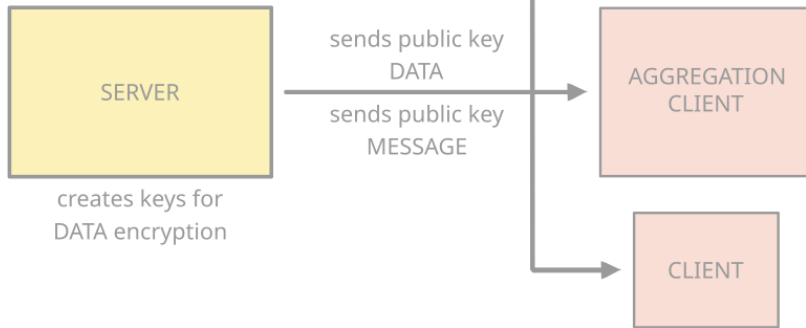

3

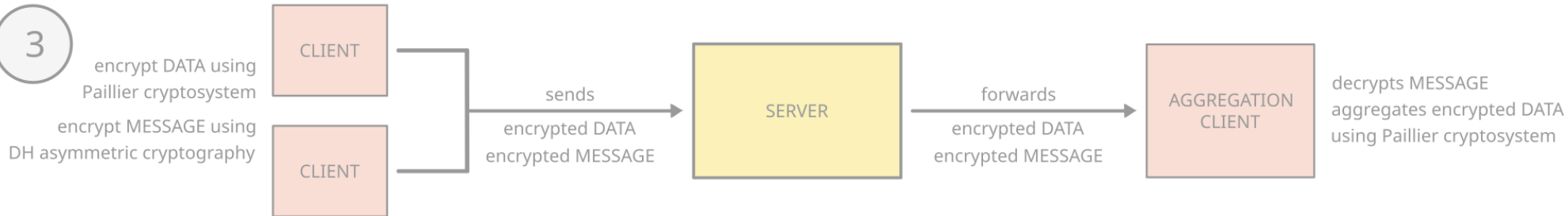

4

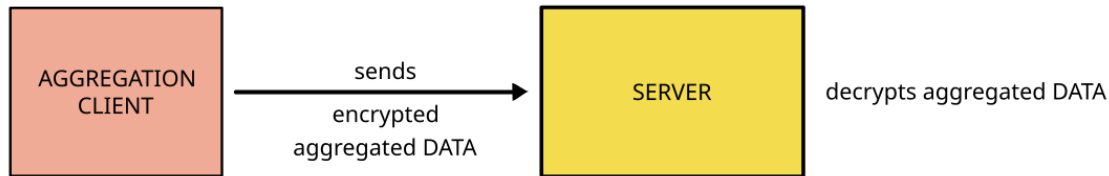

1

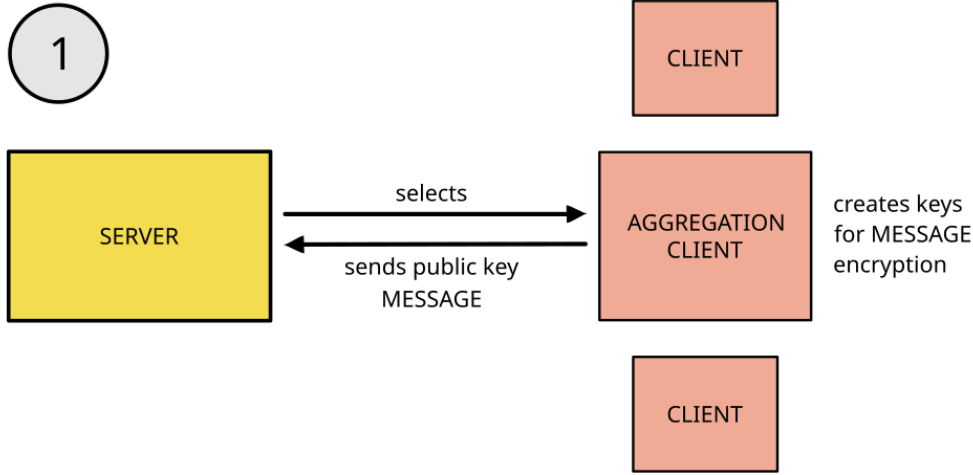

2

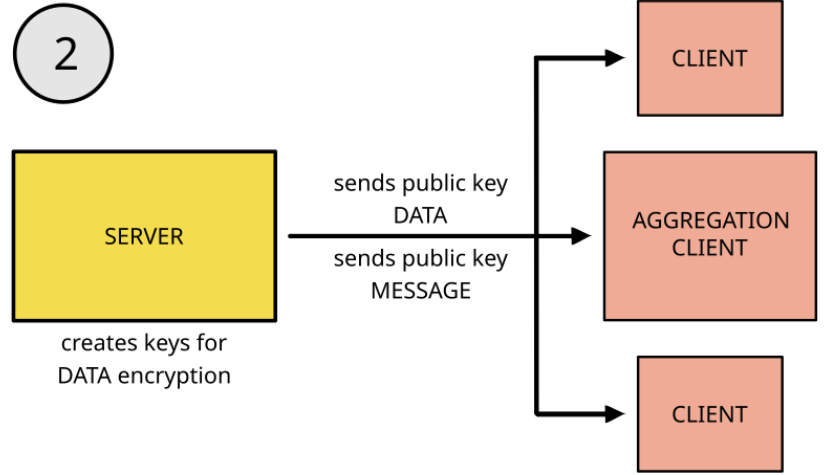

3

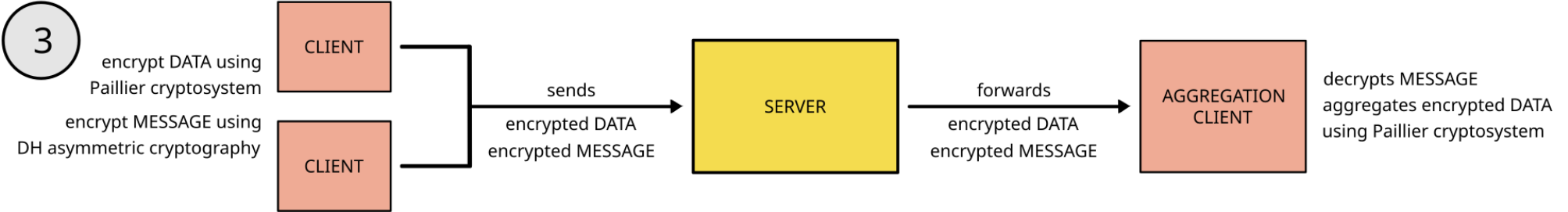

4

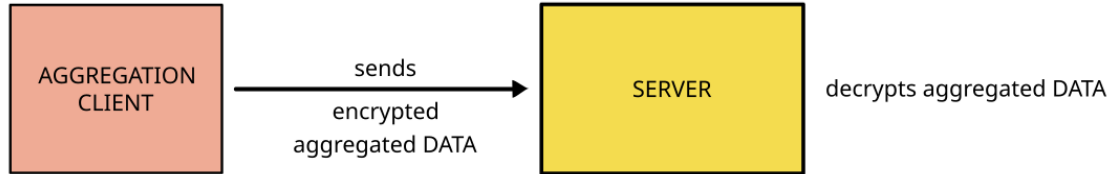

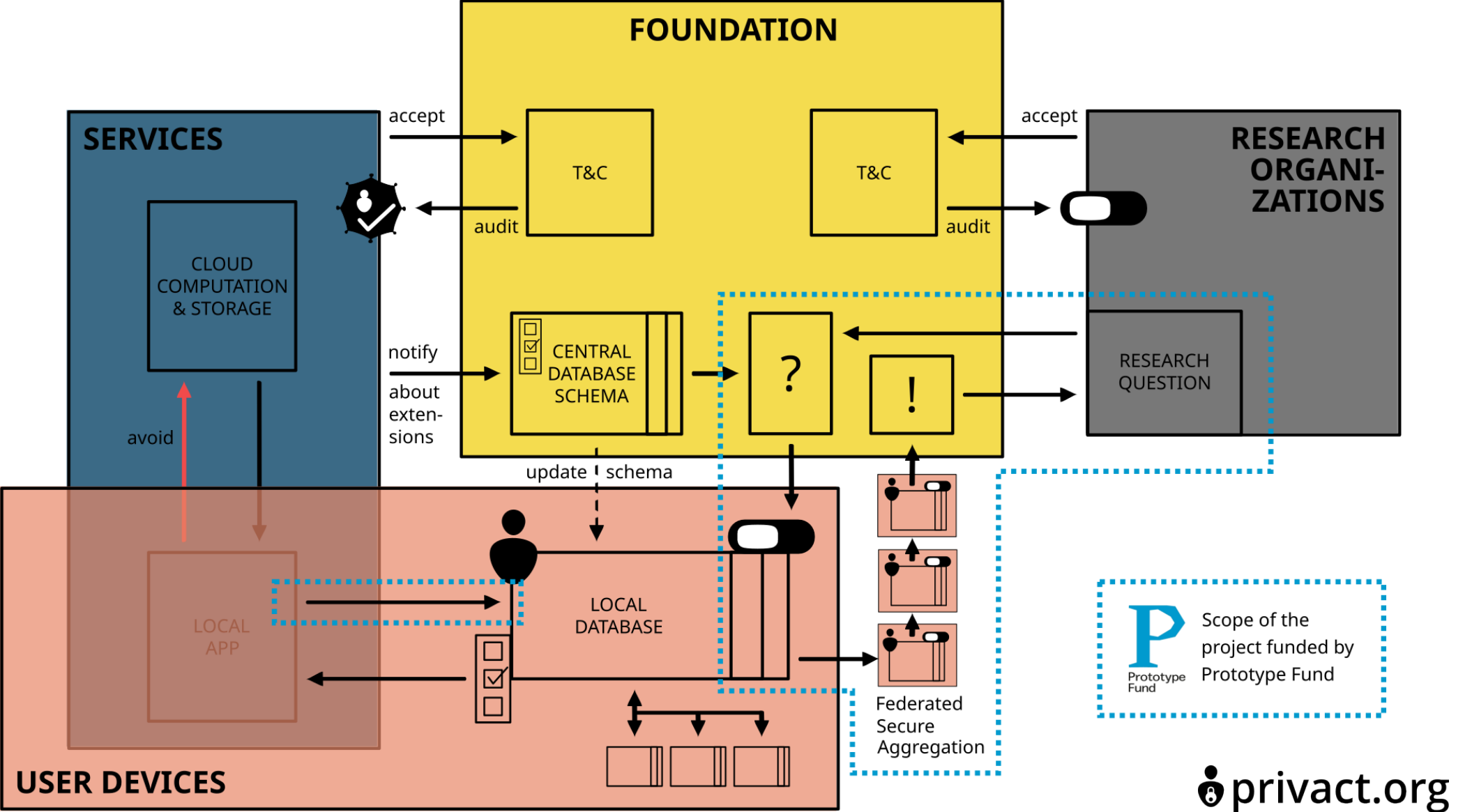

Next steps

1. Make it a product
2. KDE upstream
3. Open for other FLOSS
4. Establish Foundation
5. Open for commercial services
6. Save everyone's digital privacy

Thanks for your attention!

BoF Monday 11:00 and 14:00
with demo of the current state

bjoern@privact.org